

NITTO KOHKI AUTO HINGES

▼ ▼ ▼ **CENTER HANG A TYPE** ▼ ▼ ▼



NITTO KOHKI AUTO HINGE — developed ahead of the world with free use of original closer technology, establishing great confidence in high technological power.

AUTO HINGES (CENTER HANG TYPE)

based on the accumulation of advanced technology:

Used widely for public telephone booths throughout the country

- Designed officially by Nippon Telegraph and Telephone Corp. (NTT), being used in all the public telephone booths throughout the country. The outstanding performance and durability (500,000 or more of closing operations), appreciation among users not only in the country but also in all the countries of the world.

Concealed type (door built-in type)

- Constructed door built-in closer of pivot type, thus being easy to install. In addition, it presents a slim appearance, without affecting the beauty of a door.

Wide range usability

- Designed with a receptive base meeting the requirements for the recent tendency of thinner floor slabs in buildings, thus not causing any damage to floor surfaces in installation; the AUTO HINGE is most suitable to be used in such a place where floor hinges can be hardly installed and the arm of a door closer becomes an obstacle.

Most suitable for fire protection, open smoke ventilation and normally-opened/closed doors and air supply doors.

- Keeps closing-up of fire protection doors and opening of smoke ventilation doors & air supply doors reliably, by interlocking of smoke sensors in combined use with an electromagnetic release mechanism.

Decorated rubber plate

- Provided with a decorated rubber plate for screening the cutout windows for speed control and spring winding.

Sliding receptive base

- Minimized embedding depth
- Can be centered on-site because of having a sliding seat, thus assuring easy installation.

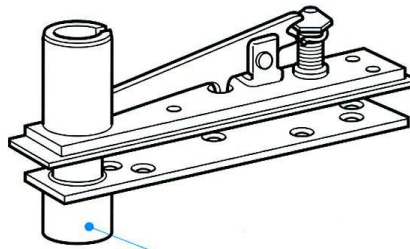

Top pivot

- Can be also installed reversely.
- Options — available for special applications.

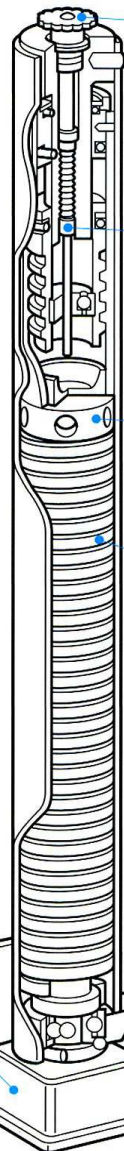

Easy closing speed adjustment

- Able to adjust the closing speed in a wide range merely by turning the speed control gear to right and left, also allowing fine adjustment.

Smooth closing

- Constructed with unique hydraulic control mechanism, realizing optimum closing operation. Any door closes smoothly and quietly.

Free closing force adjustment

- Able to adjust the closing force freely by adjusting the spring set seat.

Powerful closing force

- Has closing force sufficient to meet the sizes of any door, assuring door closing-up. It adopts special ladder type spring, having been already demonstrated for its high persistence.

Easy installation and reduced cost

- Provided with a very thin fix base plate, assuring easy installation on any door and reduced cost.

SPECIFICATIONS

Mode No.	Door size applicable(mm)			Door weight (kg)	Standard closing force(N·m)	Spring set system	Top pivot	Max. opening angle	Page			
	W	H	D									
A-8KH	800 (max.)	1,850 (max.)	36 (min)	40 (max.)	6.9	Roll-in system	N-21B	180° right or left one-side opening	3			
A-8H		2,000		50	8.9				4			
A-10H	1,000	2,100	40	85	10.8				5			
A-12H	1,200			100	15.7				6			
A-14H	1,400			130	19.7				7			
A-16H	1,600			160	24.6				8			
A-18	1,800	2,400	50	200	41.2				N-22B			9
A-22	2,200			240	49.1							10
A-26	2,600	2,600	55	310	60.9				N-23B			11
A-30	3,000			410	68.7							12
A-35A	3,500			650	73.6							13
A-40	4,000	3,000	60	800	78.5				N-25A			14

- Note: 1. Difference in opening directions are shown by the symbols, "R" for right-hand door and "L" for left-hand door, suffixed at the end of model No.
 2. Pre-set type can be used as roll-in system by unwinding the spring.
 3. Each AUTO HINGE (center hang type) consists of a main body, a receptive base, a top pivot, and a decorated rubber plate.
 4. Stop mechanism is not built in.
 5. For selection of a model refer to the [Chart for Applicable Doors] shown below.
 6. Handling of the fixed type (floor type) receptive base
 The fixed type (floor type) receptive base is prepared for a place to which the sliding receptive base is not applicable.
 7. There is a spring winding-window on both sides from A-8KH to A-16H.

CHART OF APPLICABLE DOORS

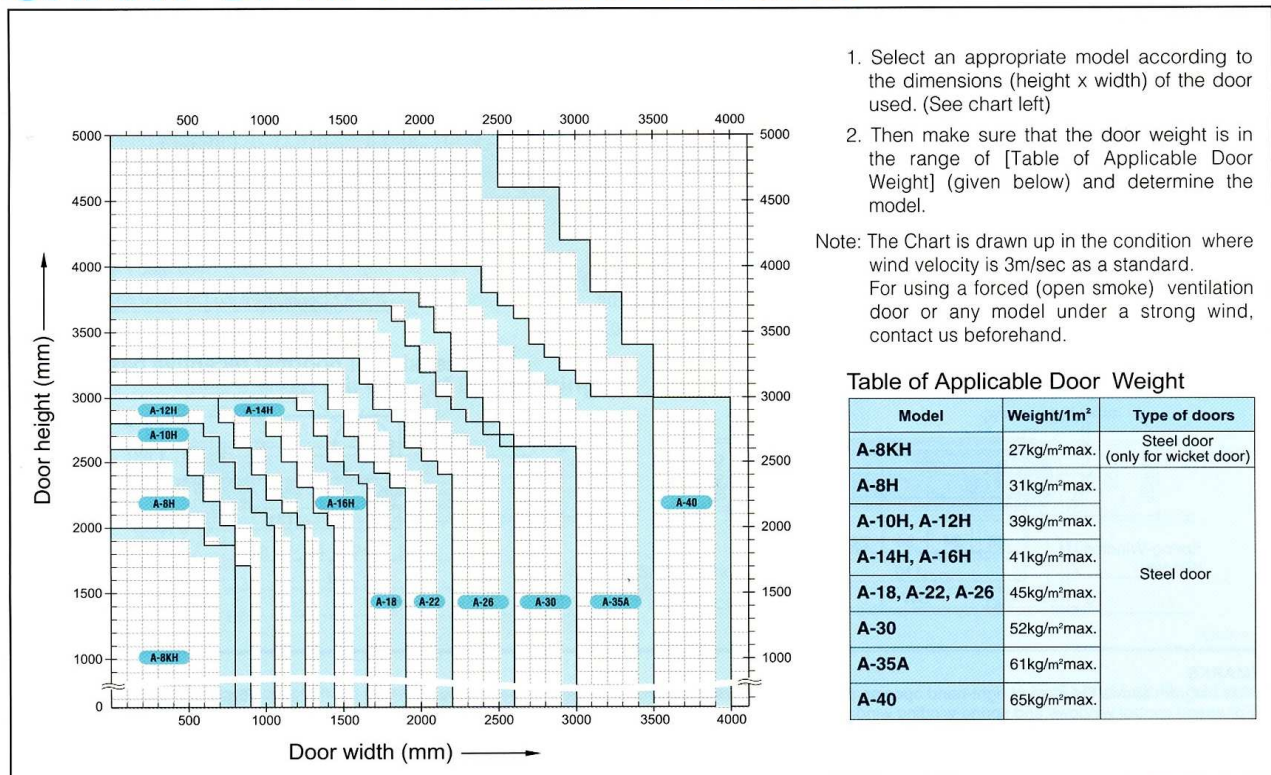

1. Select an appropriate model according to the dimensions (height x width) of the door used. (See chart left)
2. Then make sure that the door weight is in the range of [Table of Applicable Door Weight] (given below) and determine the model.

Note: The Chart is drawn up in the condition where wind velocity is 3m/sec as a standard. For using a forced (open smoke) ventilation door or any model under a strong wind, contact us beforehand.

Table of Applicable Door Weight

Model	Weight/1m ²	Type of doors
A-8KH	27kg/m ² max.	Steel door (only for wicket door)
A-8H	31kg/m ² max.	Steel door
A-10H, A-12H	39kg/m ² max.	
A-14H, A-16H	41kg/m ² max.	
A-18, A-22, A-26	45kg/m ² max.	
A-30	52kg/m ² max.	
A-35A	61kg/m ² max.	
A-40	65kg/m ² max.	

A-8H

Model		Door size applicable (mm)			Door weight (kg)	Closing force (N·m)	Spring set system	Stop mechanism	Max. opening angle	Indicating label
		W	H	D						
A-8HR	Right opening	800 max.	2000 max.	36 min.	50 max.	8.9	Roll-in system	None	180° right or left one-side opening	R : Green L : Yellow
A-8HL	Left opening									

EXTERNAL DIMENSIONS AND FITTING DIAGRAMS

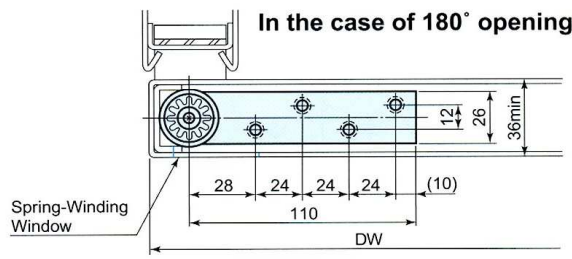
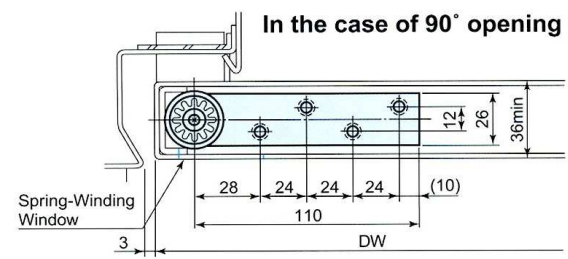
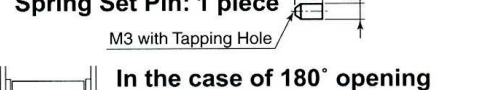
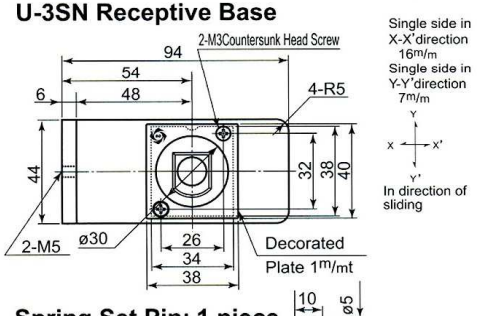
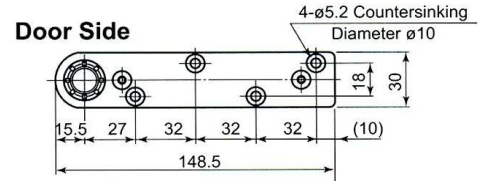
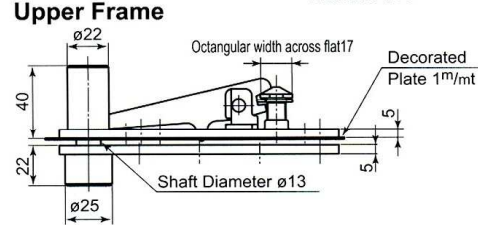
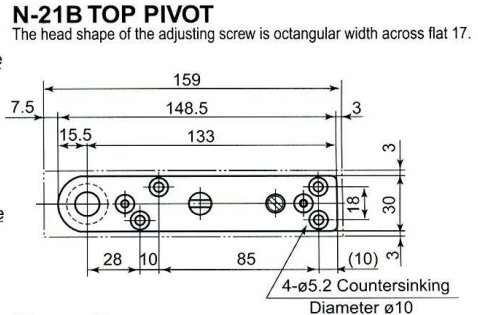
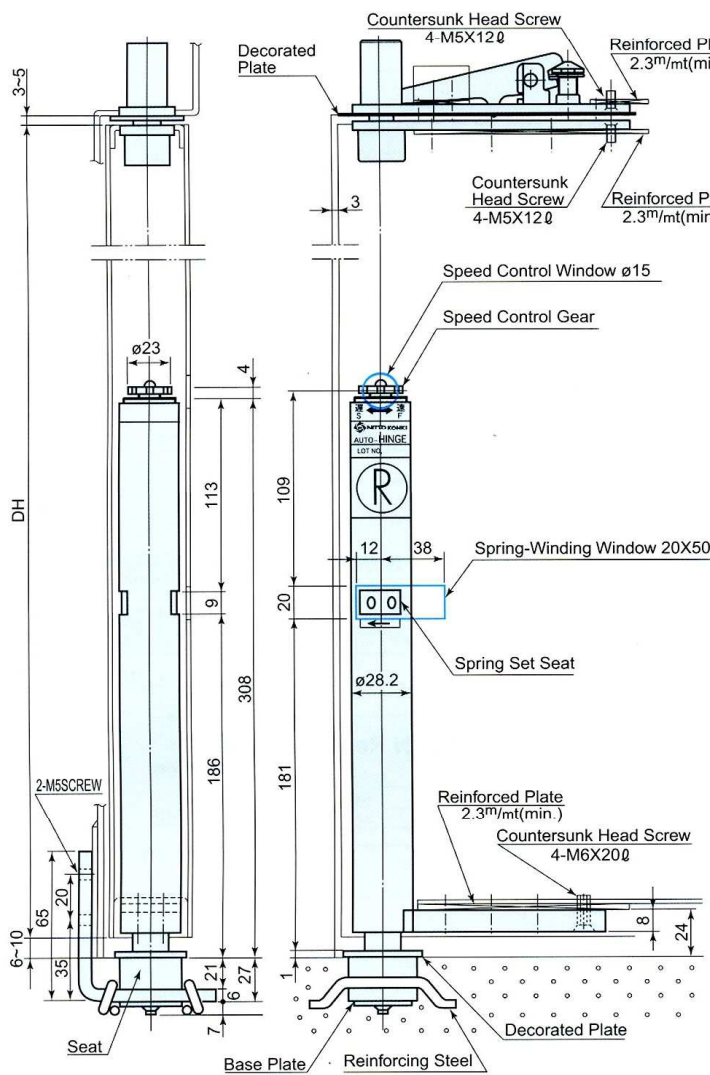

Unit: mm

- ### REMARKS
- This diagram shows the case of right-hand opening doors. There is a spring winding-window on both sides.
 - This receptive base should be adjusted and centered according to the plumb bob from the top pivot. The seat should be firmly welded on the base plate.
 - For speed control windows and spring-winding windows use the decorated rubber plate. (see page 15)
 - When U-2N receptive base is used, the door can be hanged also by preset system.

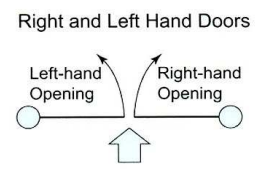

A-10H

Model		Door size applicable (mm)			Door weight (kg)	Closing force (N·m)	Spring set system	Stop mechanism	Max. opening angle	Indicating label
		W	H	D						
A-10HR	Right opening	1000 max.	2100 max.	40 min.	85 max.	10.8	Roll-in system	None	180° right or left one-side opening	R : Green L : Yellow
A-10HL	Left opening									

EXTERNAL DIMENSIONS AND FITTING DIAGRAMS

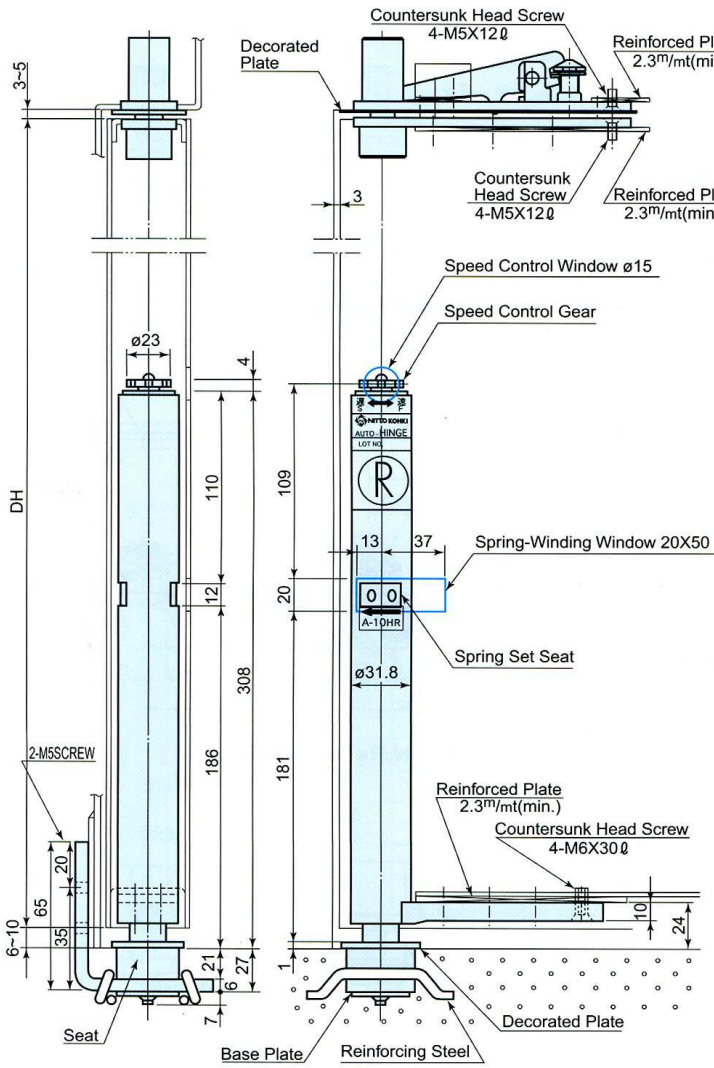

N-21B TOP PIVOT

The head shape of the adjusting screw is octagonal width across flat 17.

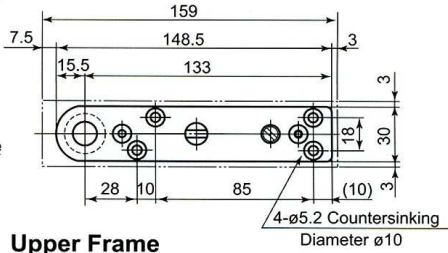

Upper Frame

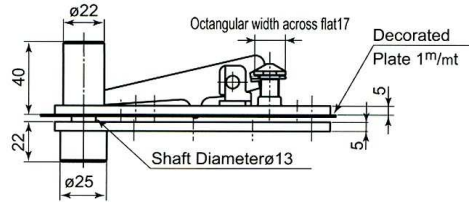

Door Side

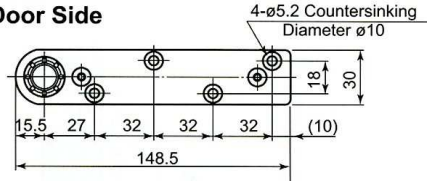

U-3SN Receptive Base

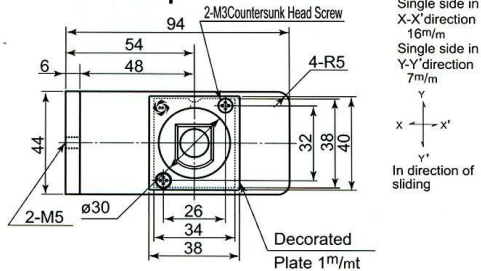

Spring Set Pin: 1 piece

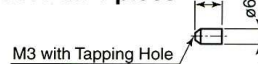

In the case of 180° opening

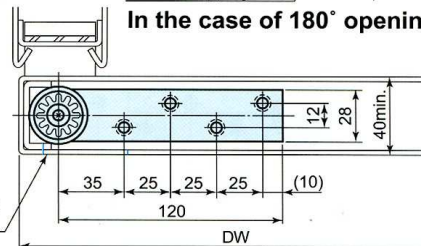

In the case of 90° opening

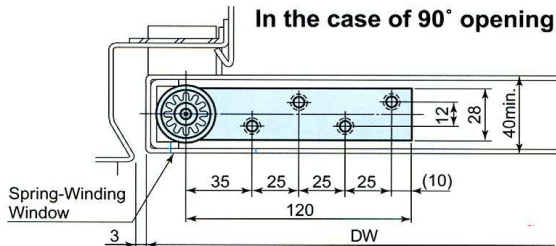

Unit: mm

REMARKS

- This diagram shows the case of right-hand opening doors. There is a spring winding-window on both sides.
- This receptive base should be adjusted and centered according to the plumb bob from the top pivot. The seat should be firmly welded on the base plate.
- For speed control windows and spring-winding windows use the decorated rubber plate. (see page 15)
- When U-2N receptive base is used, the door can be hanged also by preset system.

Right and Left Hand Doors

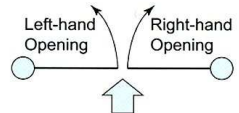

A-12H

Model		Door size applicable (mm)			Door weight (kg)	Closing force (N·m)	Spring set system	Stop mechanism	Max. opening angle	Indicating label
		W	H	D						
A-12HR	Right opening	1200 max.	2100 max.	40 min.	100 max.	15.7	Roll-in system	None	180° right or left one-side opening	R : Green L : Yellow
A-12HL	Left opening									

EXTERNAL DIMENSIONS AND FITTING DIAGRAMS

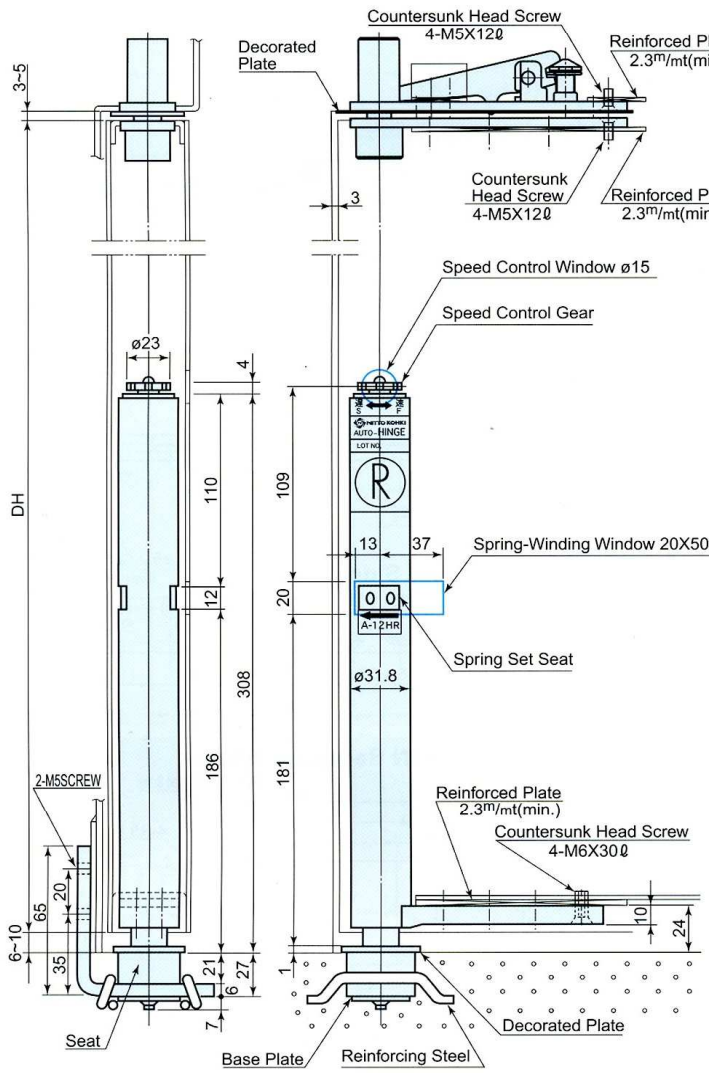

N-21B TOP PIVOT

The head shape of the adjusting screw is octagonal width across flat 17.

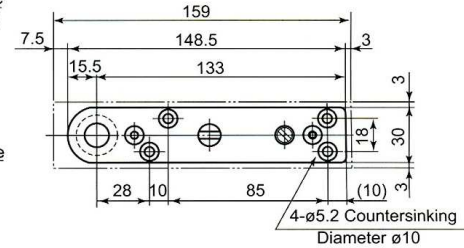

Upper Frame

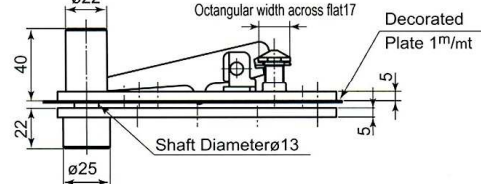

Door Side

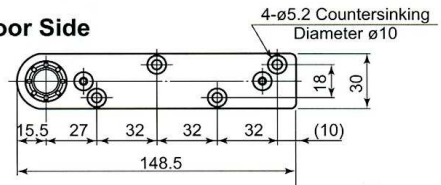

U-3SN Receptive Base

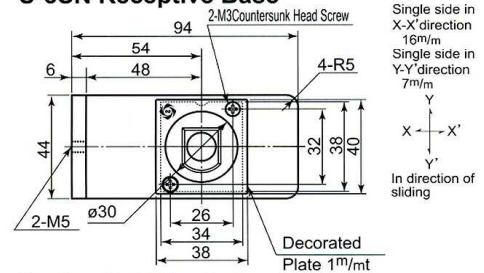

Spring Set Pin: 1 piece

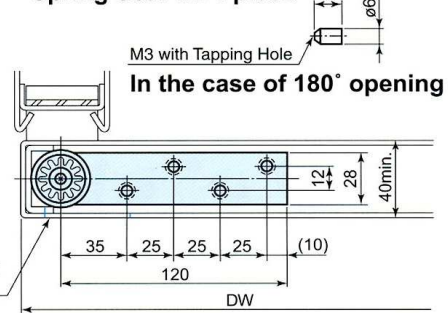

In the case of 90° opening

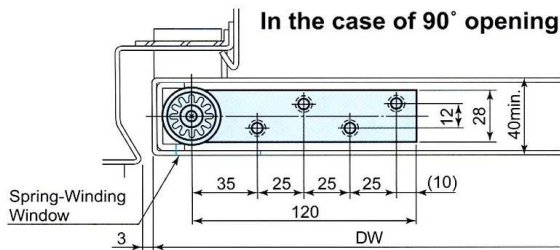

Unit: mm

REMARKS

1. This diagram shows the case of right-hand opening doors. There is a spring winding-window on both sides.
2. This receptive base should be adjusted and centered according to the plumb bob from the top pivot. The seat should be firmly welded on the base plate.
3. For speed control windows and spring-winding windows use the decorated rubber plate. (see page 15)
4. When U-2N receptive base is used, the door can be hanged also by preset system.

Right and Left Hand Doors

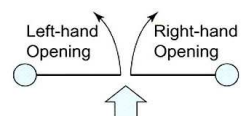

A-14H

Model		Door size applicable (mm)			Door weight (kg)	Closing force (N·m)	Spring set system	Stop mechanism	Max. opening angle	Indicating label
		W	H	D						
A-14HR	Right opening	1400 max.	2100 max.	40 min.	130 max.	19.7	Roll-in system	None	180° right or left one-side opening	R : Green L : Yellow
A-14HL	Left opening									

EXTERNAL DIMENSIONS AND FITTING DIAGRAMS

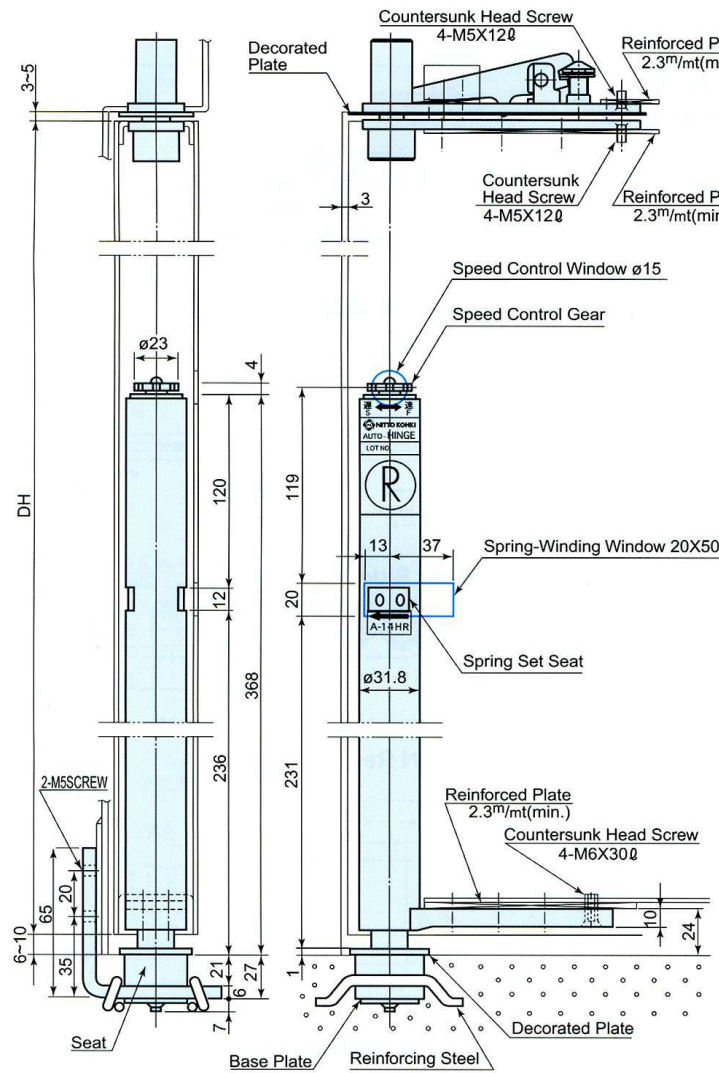

N-21B TOP PIVOT

The head shape of the adjusting screw is octagonal width across flat 17.

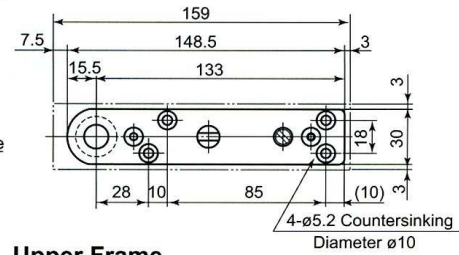

Upper Frame

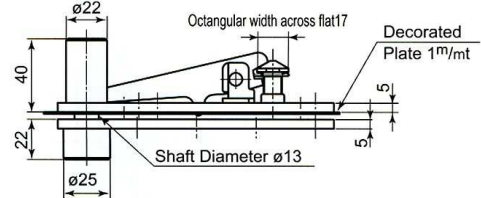

Door Side

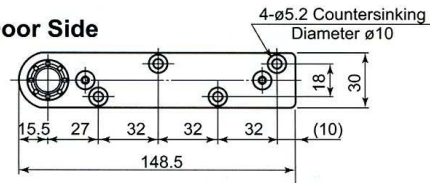

U-3SN Receptive Base

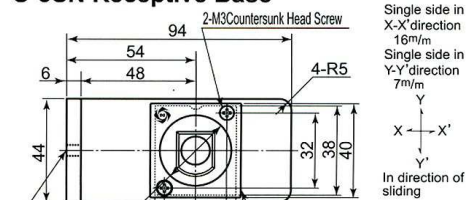

Spring Set Pin: 1 piece

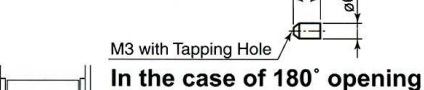

In the case of 90° opening

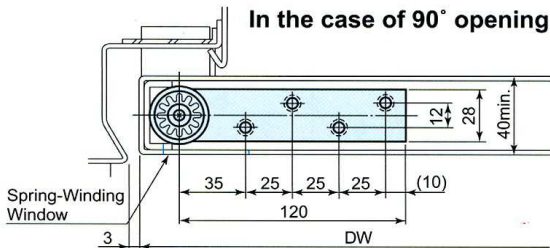

In the case of 180° opening

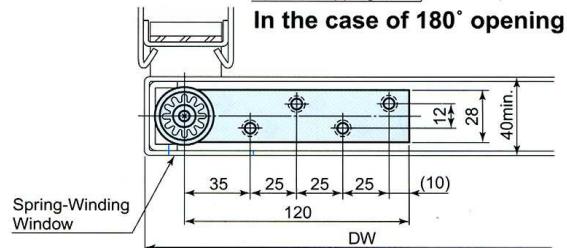

Unit: mm

REMARKS

1. This diagram shows the case of right-hand opening doors. There is a spring winding-window on both sides.
2. This receptive base should be adjusted and centered according to the plumb bob from the top pivot. The seat should be firmly welded on the base plate.
3. For speed control windows and spring-winding windows use the decorated rubber plate. (see page 15)
4. When U-2N receptive base is used, the door can be hanged also by preset system.

Right and Left Hand Doors

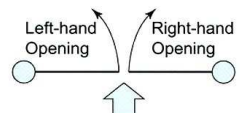

A-16H

Model		Door size applicable (mm)			Door weight (kg)	Closing force (N·m)	Spring set system	Stop mechanism	Max. opening angle	Indicating label
		W	H	D						
A-16HR	Right opening	1600 max.	2400 max.	45 min.	160 max.	24.6	Roll-in system	None	180° right or left one-side opening	R : Green L : Yellow
A-16HL	Left opening									

EXTERNAL DIMENSIONS AND FITTING DIAGRAMS

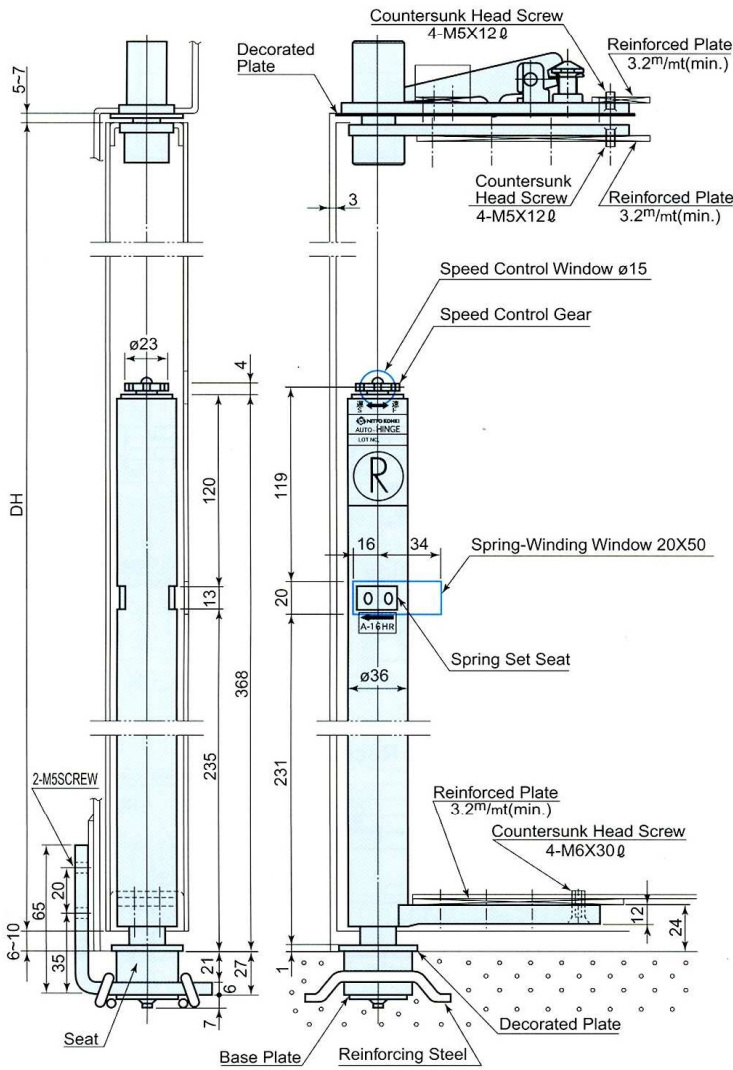

N-22B TOP PIVOT

The head shape of the adjusting screw is octagonal width across flat 17.

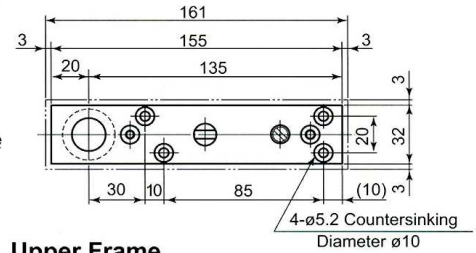

Upper Frame

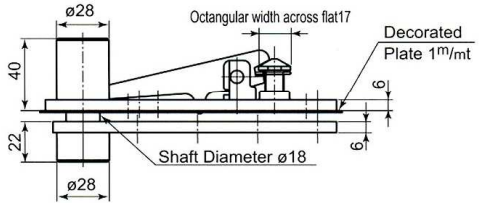

Door Side

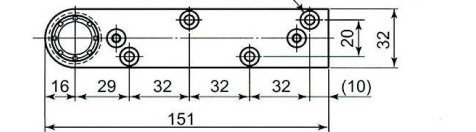

U-3SN Receptive Base

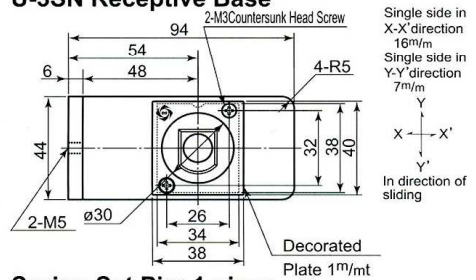

Spring Set Pin: 1 piece

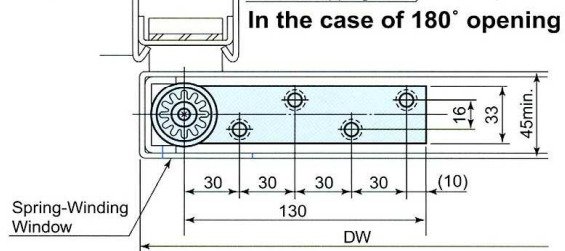
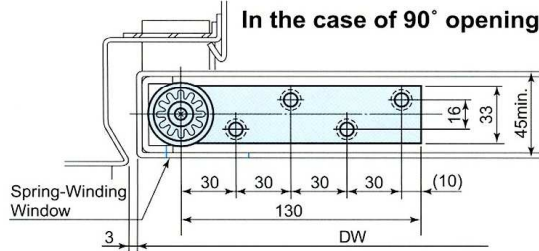

Unit: mm

REMARKS

1. This diagram shows the case of right-hand opening doors. There is a spring winding-window on both sides.
2. This receptive base should be adjusted and centered according to the plumb bob from the top pivot. The seat should be firmly welded on the base plate.
3. For speed control windows and spring-winding windows use the decorated rubber plate. (see page 15)

Right and Left Hand Doors

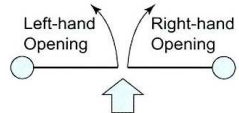

A-18

Model		Door size applicable (mm)			Door weight (kg)	Closing force (N·m)	Spring set system	Stop mechanism	Max. opening angle	Indicating label
		W	H	D						
A-18R	Right opening	1800 max.	2400 max.	50 min.	200 max.	41.2	Roll-in system	None	180° right or left one-side opening	R : Green L : Yellow
A-18L	Left opening									

EXTERNAL DIMENSIONS AND FITTING DIAGRAMS

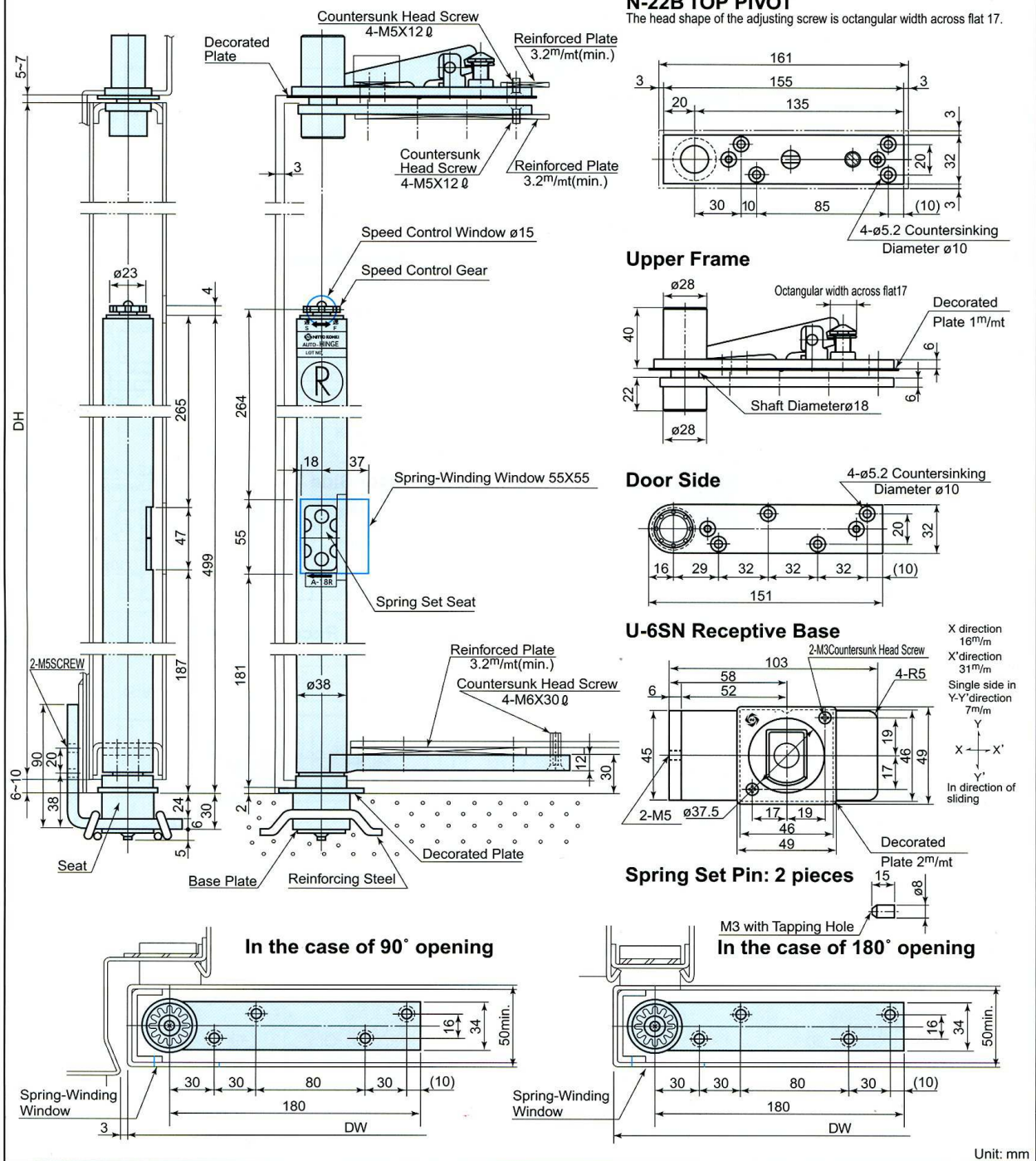

REMARKS

1. This diagram shows the case of right-hand opening doors.
2. This receptive base should be adjusted and centered according to the plumb bob from the top pivot. The seat should be firmly welded on the base plate.
3. For speed control windows and spring-winding windows use the decorated rubber plate. (see page 15)

Right and Left Hand Doors

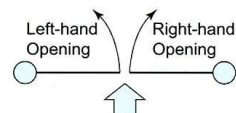

A-22

Model		Door size applicable (mm)			Door weight (kg)	Closing force (N·m)	Spring set system	Stop mechanism	Max. opening angle	Indicating label
		W	H	D						
A-22R	Right opening	2200 max.	2400 max.	50 min.	240 max.	49.1	Roll-in system	None	180° right or left one-side opening	R : Green L : Yellow
A-22L	Left opening									

EXTERNAL DIMENSIONS AND FITTING DIAGRAMS

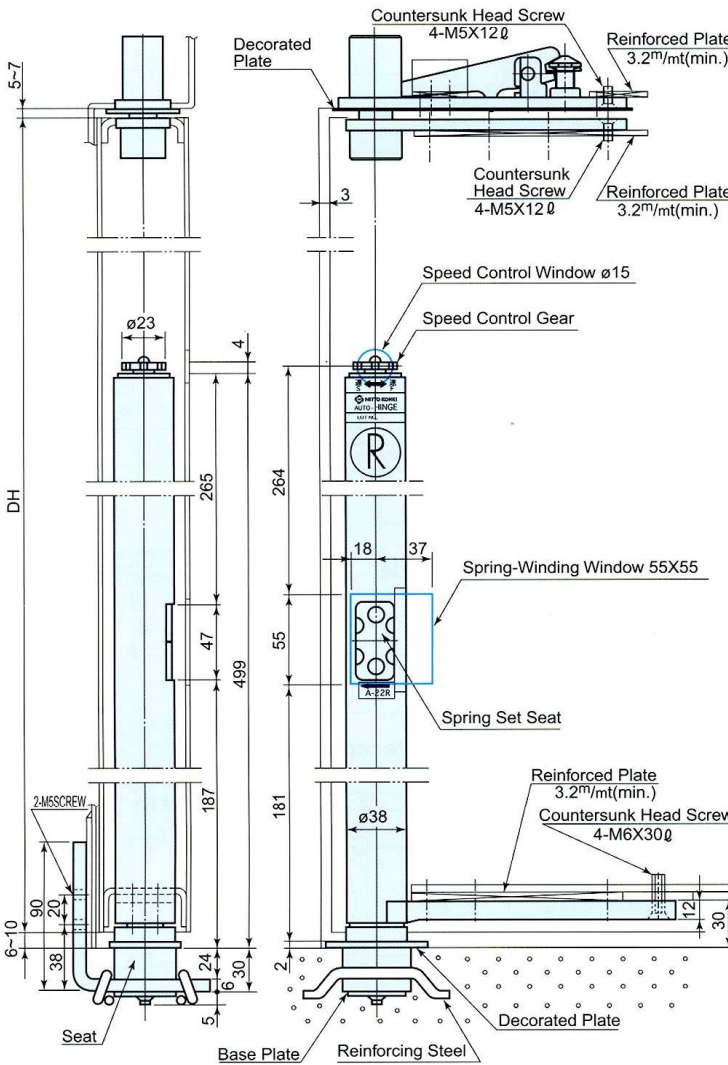

N-22B TOP PIVOT

The head shape of the adjusting screw is octagonal width across flat 17.

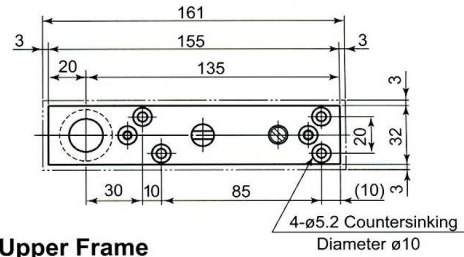

Upper Frame

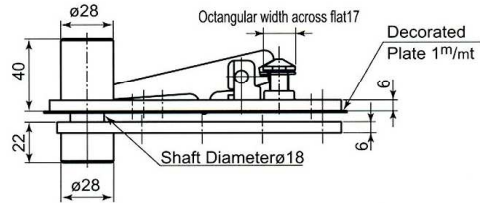

Door Side

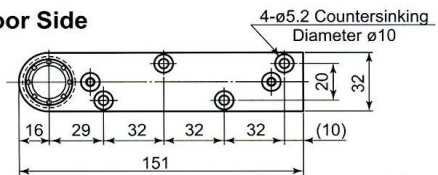

U-6SN Receptive Base

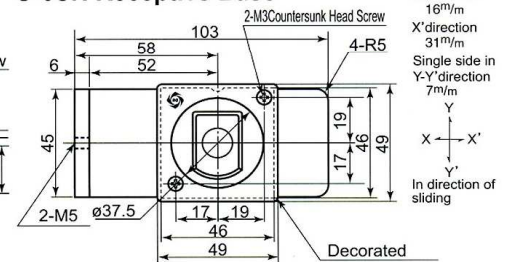

Spring Set Pin: 2 pieces

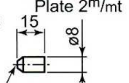

In the case of 90° opening

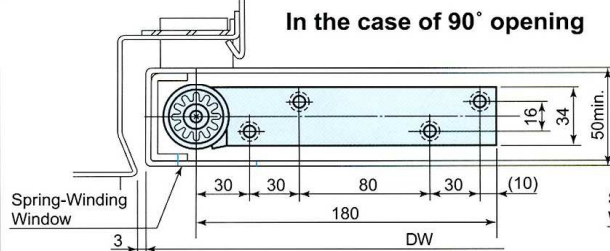

In the case of 180° opening

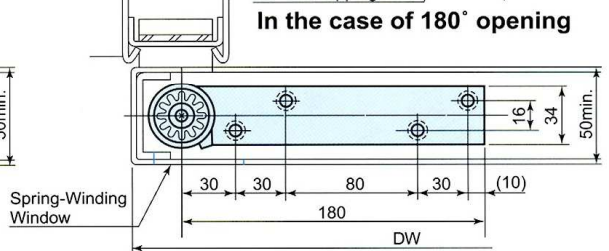

Unit: mm

REMARKS

1. This diagram shows the case of right-hand opening doors.
2. This receptive base should be adjusted and centered according to the plumb bob from the top pivot. The seat should be firmly welded on the base plate.
3. For speed control windows and spring-winding windows use the decorated rubber plate. (see page 15)

Right and Left Hand Doors

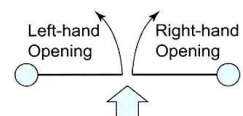

A-26

Model		Door size applicable (mm)			Door weight (kg)	Closing force (N·m)	Spring set system	Stop mechanism	Max. opening angle	Indicating label
		W	H	D						
A-26R	Right opening	2600 max.	2600 max.	55 min.	310 max.	60.9	Roll-in system	None	180° right or left one-side opening	R : Green L : Yellow
A-26L	Left opening									

EXTERNAL DIMENSIONS AND FITTING DIAGRAMS

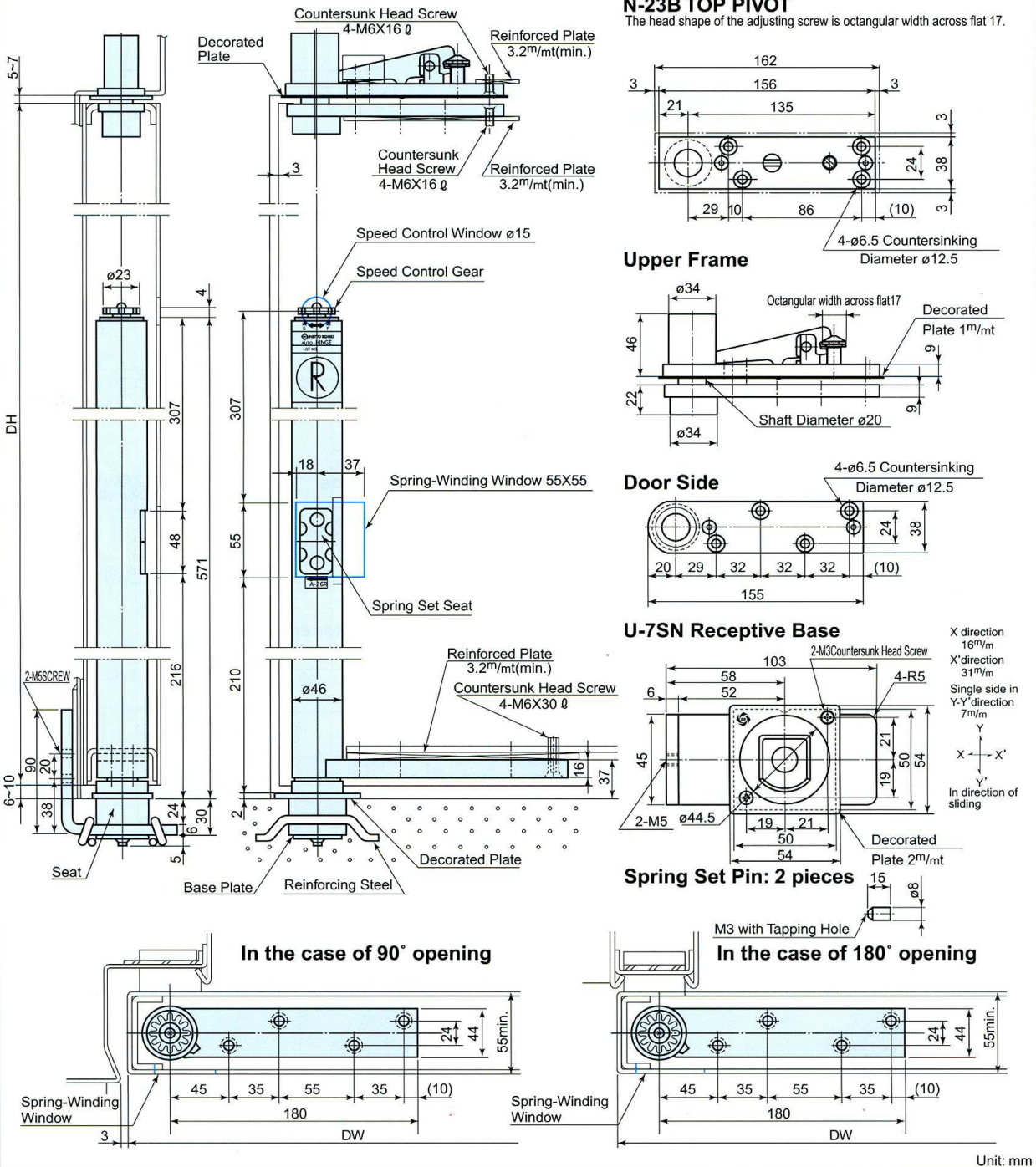

REMARKS

1. This diagram shows the case of right-hand opening doors.
2. This receptive base should be adjusted and centered according to the plumb bob from the top pivot. The seat should be firmly welded on the base plate.
3. For speed control windows and spring-winding windows use the decorated rubber plate. (see page 15)

Right and Left Hand Doors

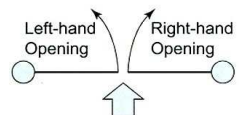

Unit: mm

A-30

Model		Door size applicable (mm)			Door weight (kg)	Closing force (N-m)	Spring set system	Stop mechanism	Max. opening angle	Indicating label
		W	H	D						
A-30R	Right opening	3000 max.	2600 max.	55 min.	410 max.	68.7	Roll-in system	None	180° right or left one-side opening	R : Green L : Yellow
A-30L	Left opening									

EXTERNAL DIMENSIONS AND FITTING DIAGRAMS

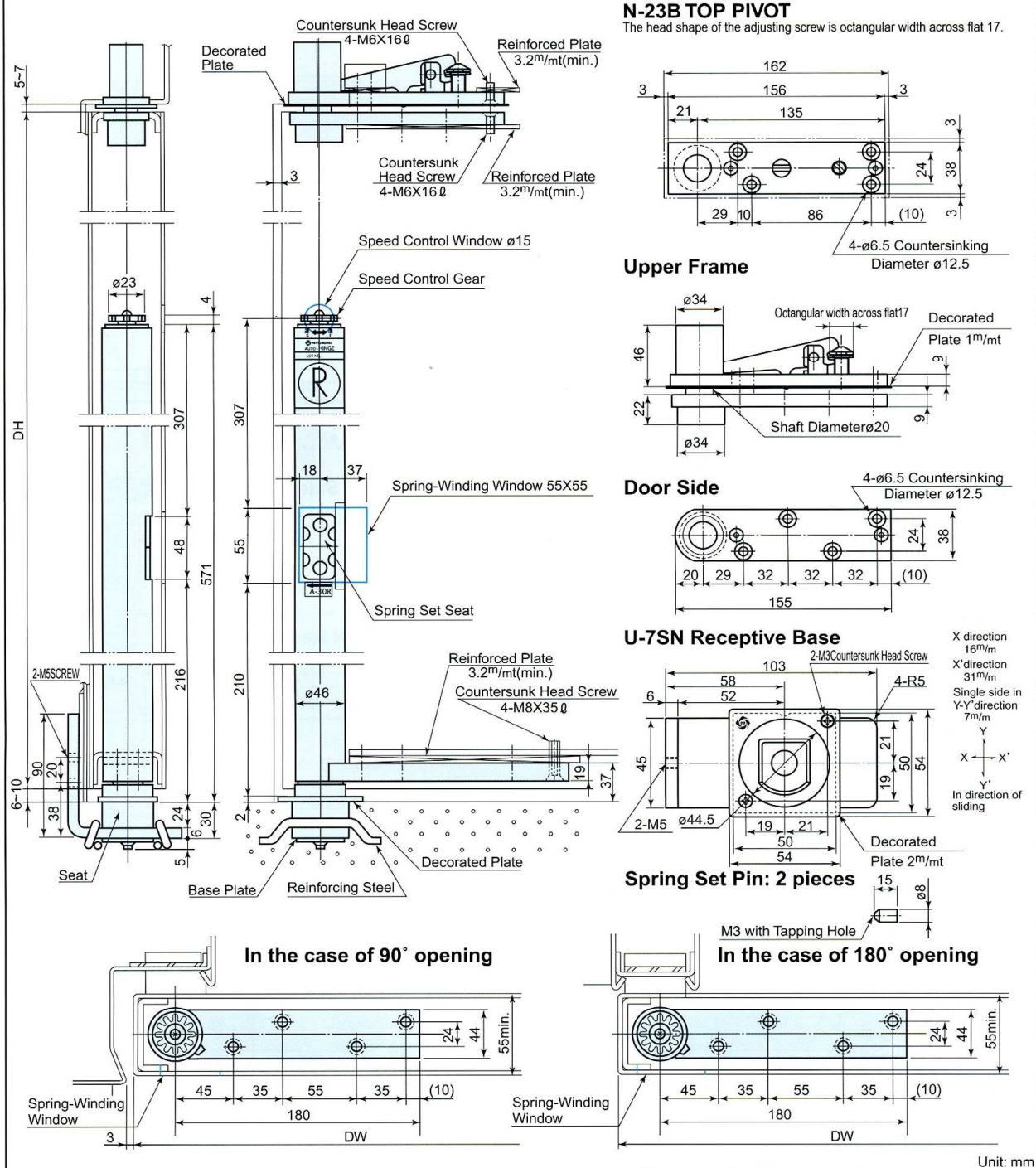

REMARKS

1. This diagram shows the case of right-hand opening doors.
2. This receptive base should be adjusted and centered according to the plumb bob from the top pivot. The seat should be firmly welded on the base plate.
3. For speed control windows and spring-winding windows use the decorated rubber plate. (see page 15)

Right and Left Hand Doors

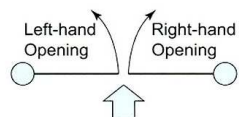

A-35A

Model		Door size applicable (mm)			Door weight (kg)	Closing force (N·m)	Spring set system	Stop mechanism	Max. opening angle	Indicating label
		W	H	D						
A-35AR	Right opening	3500 max.	3000 max.	55 min.	650 max.	73.6	Roll-in system	None	180 right or left one-side opening	R : Green L : Yellow
A-35AL	Left opening									

EXTERNAL DIMENSIONS AND FITTING DIAGRAMS

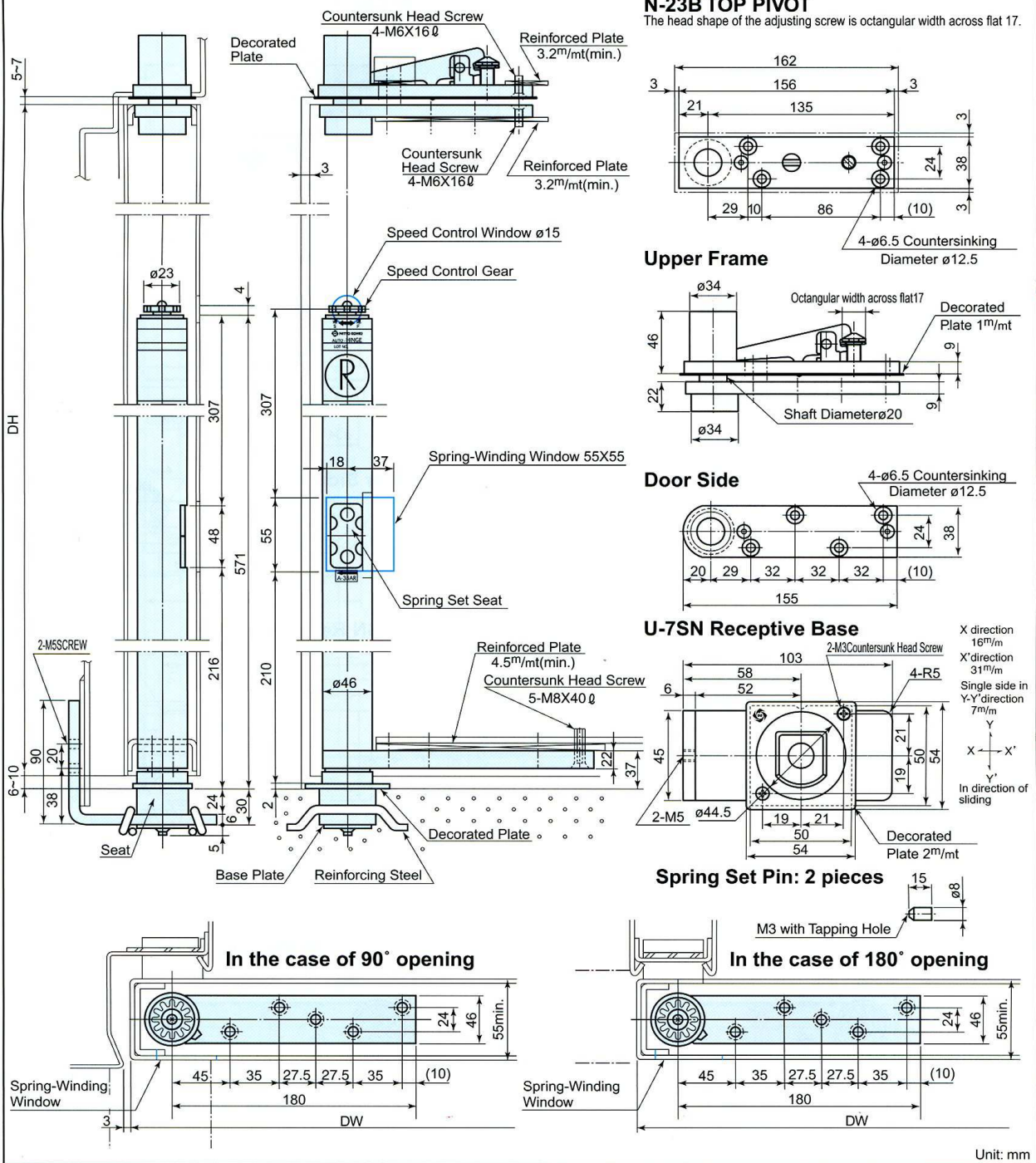

REMARKS

1. This diagram shows the case of right-hand opening doors.
2. This receptive base should be adjusted and centered according to the plumb bob from the top pivot. The seat should be firmly welded to the base plate.
3. For speed control windows and spring-winding windows use the decorated rubber plate. (see page 15)

Right and Left Hand Doors

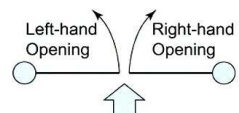

A-40

Model		Door size applicable (mm)			Door weight (kg)	Closing force (N·m)	Spring set system	Stop mechanism	Max. opening angle	Indicating label
		W	H	D						
A-40R	Right opening	4000 max.	3000 max.	65 min.	800 max.	78.5	Roll-in system	None	180° right or left one-side opening	R : Green L : Yellow
A-40L	Left opening									

EXTERNAL DIMENSIONS AND FITTING DIAGRAMS

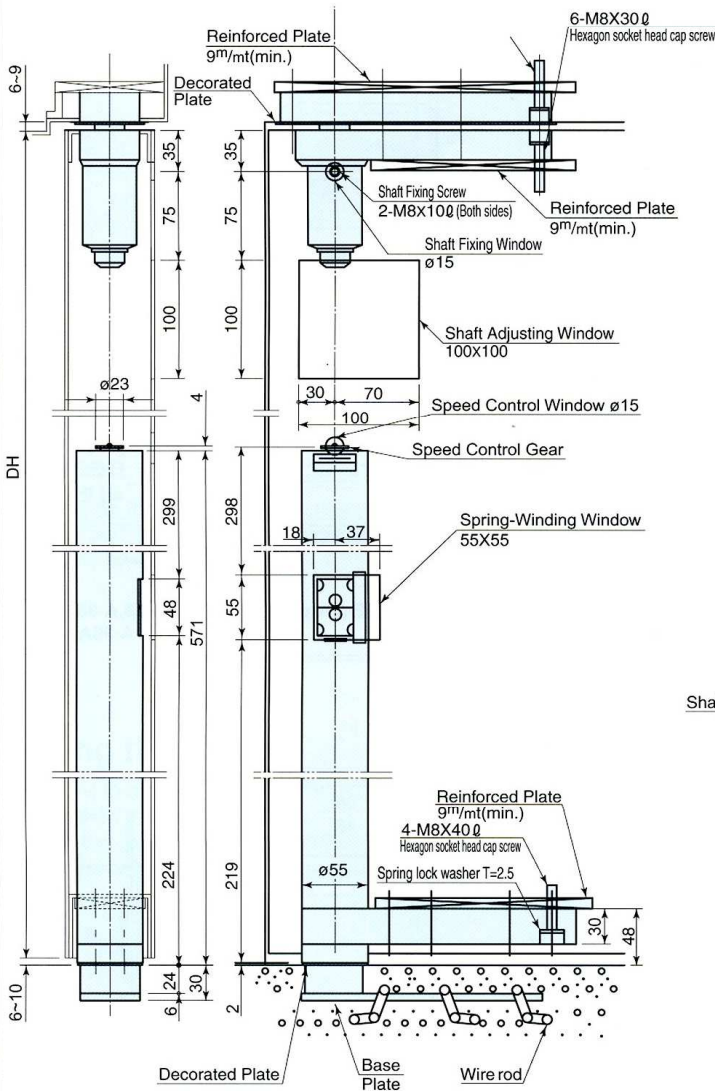

N-25A TOP PIVOT

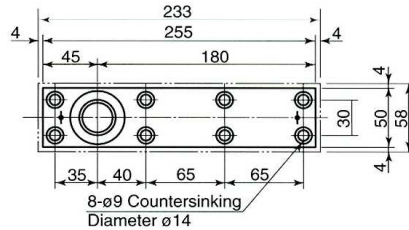

Upper Frame

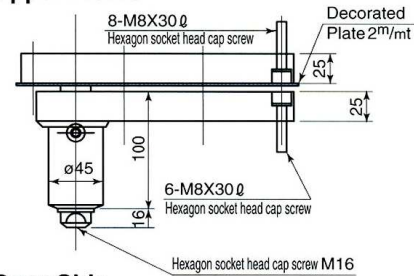

Door Side

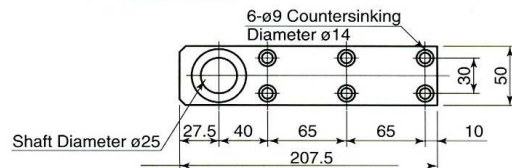

U-7N Receptive Base

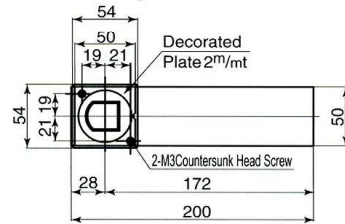

Spring Set Pin: 2 pieces

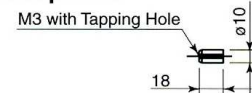

In the case of 90° opening

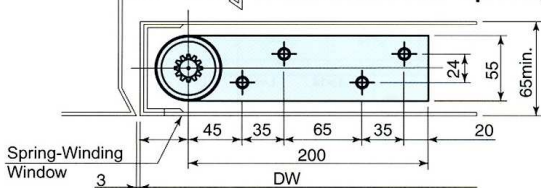

In the case of 180° opening

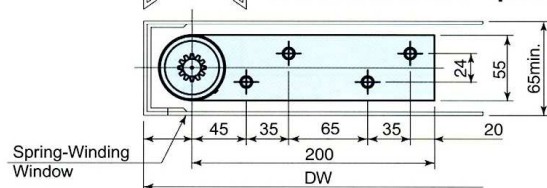

Unit: mm

REMARKS

- This diagram shows the case of right-hand opening doors.
- This receptive base should be adjusted and centered according to the plumb bob from the top pivot. The seat should be firmly welded on the base plate.
- For speed control windows and spring-winding windows use the decorated rubber plate. (see page 15) Prepare the shaft fixing window.
- A big force is applied to the installation unit. Perform reinforcement with enough strength.
- Screw in the top pivot securely as turning the shaft upward and then tighten the shaft fixing screw.

Right and Left Hand Doors

